



HYGIENISCHE KREISELPUMPE Baureihe CR



HYGIENE BIOTECHNOLOGY INDUSTRIAL

Kreiselpumpe mit schraubenförmigem Axiallaufrad zur schonenden Förderung feststoffbeladener Medien. Kompakte Bauweise als Blockpumpe mit separat gelagerter Pumpenwelle für hohe Laufruhe und Betrieb an beliebigem Normmotor.

Alle medienberührten Bauteile sind aus massivem Edelstahl 1.4404/1.4409 (AISI 316L) gefertigt.

Dank der einfachen Bauweise kann die Pumpe schnell für Wartungs- und Reinigungsarbeiten geöffnet werden.

Der Klemmverschluss ermöglicht außerdem eine beliebige Ausrichtung des Druckstutzens.

Die Wellenabdichtung ist als Gleitringdichtung gestaltet und damit langlebig und sicher.

Der Aufbau der Pumpe folgt den Richtlinien des Hygienic Designs und ermöglicht eine schnelle und einfache CIP/SIP Reinigung.



Pumpe CR mit Verkleidung

Aufgrund des schraubenförmigen Laufrads und der Gehäusegeometrie hat die Pumpe große Durchgangsweiten und eignet sich ideal für den schonenden Transport empfindlicher Medien mit hohem Feststoffgehalt. Damit vereint sie die positiven Eigenschaften einer Kreiselpumpe mit der Funktionsweise einer Exzentrerschneckenpumpe und ist die erste Wahl für viele Anwendungen der Lebensmittelindustrie wie z.B. den Transport von Gemüse, Obst, Konserven, Maische, Most & Wein, Öl, Teigwaren, Getreidesamen.

TECHNISCHE DATEN

Förderleistung: bis zu 150 m³/h

Förderhöhe: bis zu 20 m

Maximaler Betriebsdruck: 10 bar

Temperaturbereich: -10°C bis 100°C

Ausführung der Wellenabdichtung:

Gleitringdichtung nach Normabmessung der EN 12756.

- Einfache Gleitringdichtung innenliegend
- Einfache Gleitringdichtung, innenliegend, gekapselt
- Doppelte Gleitringdichtung für drucklose Spülung oder Sperrdrucksystem

Dichtungsmaterialien (gemäß EGV 1935/2004 & FDA):

EPDM, FPM, FKM, NBR, FEP, FFKM

Mögliche Anschlüsse:

Alle Gewinde oder Flansche gängiger Standards wie DIN 11851, DIN 11864, SMS, EN 1092-1 etc.



ALLGEMEINE LEISTUNGSDIAGRAMME

(Die Leistungen beziehen sich auf Wasser bei 20°C - 1013 mbar, Die Angaben sind unverbindlich)

| | | | | | | |
|---|----------------------------------|-------------------------------------|-------------------------------|-------------------------------|---|--------------------------------------|
| POMPA TIPO <i>Pump type</i> | | CR 65 | | | n 920/1110 giri / min <i>r. p. m.</i> | |
| GIRANTE — Impeller | | | | | | |
| TIPO <i>Type</i> | N° di pale <i>n° of vanes</i> | Pass. sferico <i>max. sphere</i> | Ø max <i>max. diameter</i> | Ø min <i>min. diameter</i> | Bocche tipo <i>Ports type</i> | Bocca aspir. <i>Suction port</i> |
| APERTA | 1 Elica | 33 mm | 156 mm | — mm | DIN 11851 | DN 65 |
| | | | | | | Bocca mand. <i>Discharge port</i> |
| | | | | | | DN 65 |
| CARATTERISTICHE DI FUNZIONAMENTO CON ACQUA PULITA A 20°C - PESO SPECIFICO 1 (kg/dm ³) <i>Curves show performance with clear water at 20°C - Specific gravity 1 (kg/dm³)</i> | | | | | | |

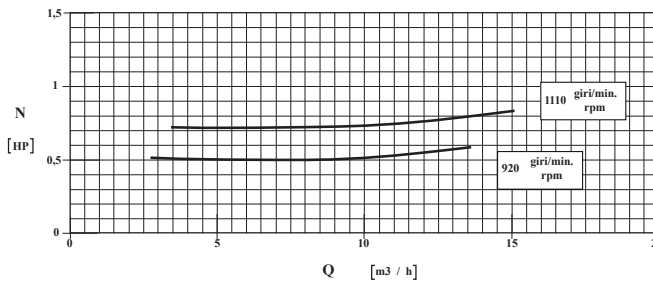
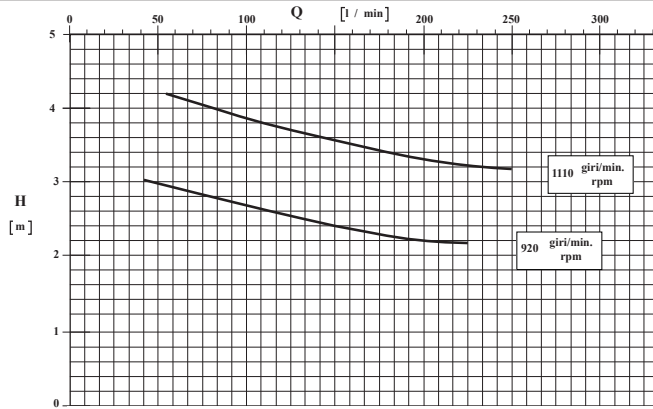

| | | | | | | |
|---|----------------------------------|-------------------------------------|-------------------------------|-------------------------------|---|--------------------------------------|
| POMPA TIPO <i>Pump type</i> | | CR 80 | | | n 960/1150 giri / min <i>r. p. m.</i> | |
| GIRANTE — Impeller | | | | | | |
| TIPO <i>Type</i> | N° di pale <i>n° of vanes</i> | Pass. sferico <i>max. sphere</i> | Ø max <i>max. diameter</i> | Ø min <i>min. diameter</i> | Bocche tipo <i>Ports type</i> | Bocca aspir. <i>Suction port</i> |
| APERTA | 1 Elica | 45 mm | 178 mm | — mm | DIN 11851 | DN 80 |
| | | | | | | Bocca mand. <i>Discharge port</i> |
| | | | | | | DN 80 |
| CARATTERISTICHE DI FUNZIONAMENTO CON ACQUA PULITA A 20°C - PESO SPECIFICO 1 (kg/dm ³) <i>Curves show performance with clear water at 20°C - Specific gravity 1 (kg/dm³)</i> | | | | | | |

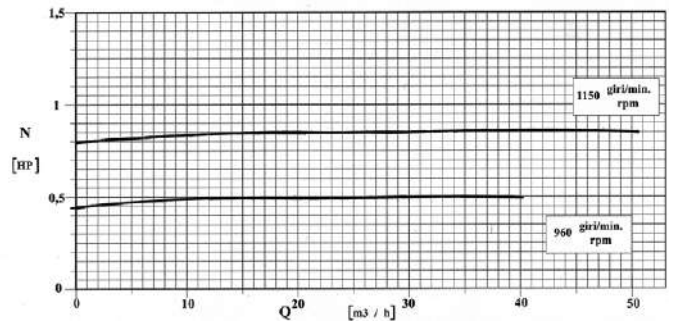
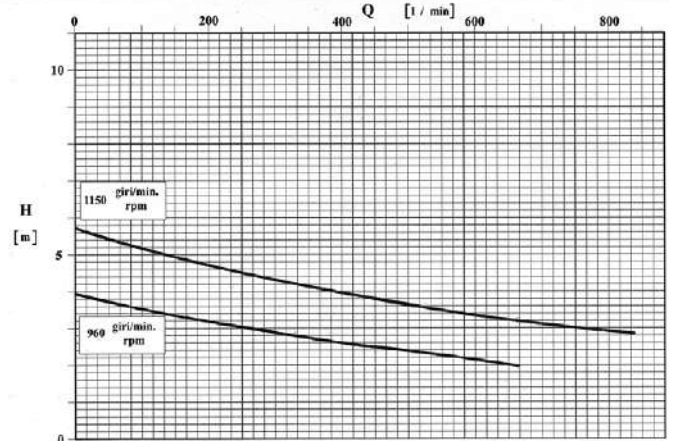

| | | | | | | |
|---|----------------------------------|-------------------------------------|-------------------------------|-------------------------------|---|--------------------------------------|
| POMPA TIPO <i>Pump type</i> | | CR 100 | | | n 960/1150 giri / min <i>r. p. m.</i> | |
| GIRANTE — Impeller | | | | | | |
| TIPO <i>Type</i> | N° di pale <i>n° of vanes</i> | Pass. sferico <i>max. sphere</i> | Ø max <i>max. diameter</i> | Ø min <i>min. diameter</i> | Bocche tipo <i>Ports type</i> | Bocca aspir. <i>Suction port</i> |
| APERTA | 1 Elica | 58 mm | 210 mm | — mm | DIN 11851 | DN 100 |
| | | | | | | Bocca mand. <i>Discharge port</i> |
| | | | | | | DN 100 |
| CARATTERISTICHE DI FUNZIONAMENTO CON ACQUA PULITA A 20°C - PESO SPECIFICO 1 (kg/dm ³) <i>Curves show performance with clear water at 20°C - Specific gravity 1 (kg/dm³)</i> | | | | | | |

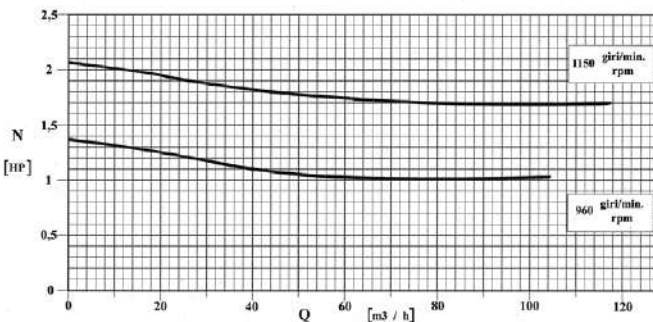
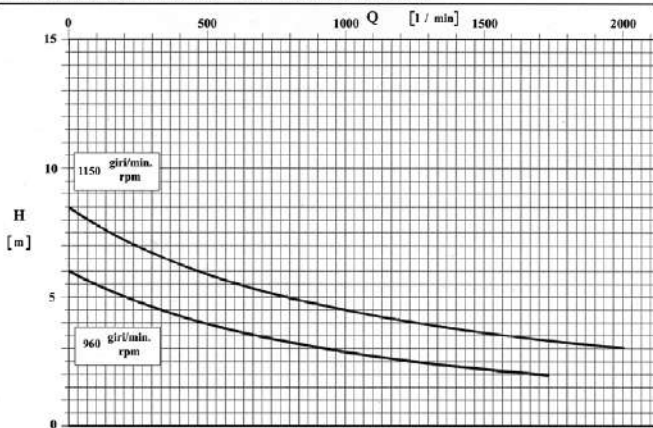

| | | | | | | |
|---|----------------------------------|-------------------------------------|-------------------------------|-------------------------------|---|--------------------------------------|
| POMPA TIPO <i>Pump type</i> | | CR 125 | | | n 960/1150 giri / min <i>r. p. m.</i> | |
| GIRANTE — Impeller | | | | | | |
| TIPO <i>Type</i> | N° di pale <i>n° of vanes</i> | Pass. sferico <i>max. sphere</i> | Ø max <i>max. diameter</i> | Ø min <i>min. diameter</i> | Bocche tipo <i>Ports type</i> | Bocca aspir. <i>Suction port</i> |
| APERTA | 1 Elica | 63 mm | 260 mm | — mm | DIN 11851 | DN 125 |
| | | | | | | Bocca mand. <i>Discharge port</i> |
| | | | | | | DN 125 |
| CARATTERISTICHE DI FUNZIONAMENTO CON ACQUA PULITA A 20°C - PESO SPECIFICO 1 (kg/dm ³) <i>Curves show performance with clear water at 20°C - Specific gravity 1 (kg/dm³)</i> | | | | | | |

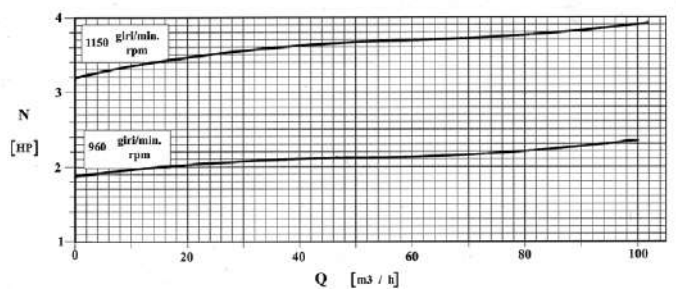
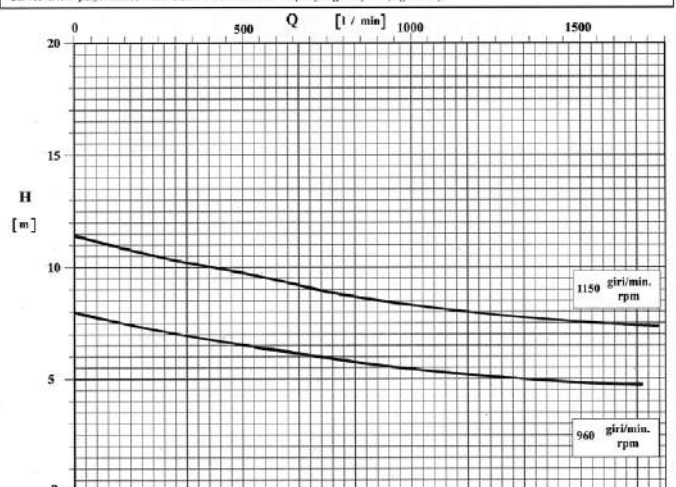

| | | | | | |
|---|----------------------------------|-------------------------------------|-------------------------------|---|--------------------------------------|
| POMPA TIPO Pump type | | CR 65 | | n 1400/1750 giri / min r. p. m. | |
| GIRANTE — Impeller | | | | | |
| TIPO Type | N° di pale n° of vanes | Pass. sferico max. sphere | Ø max max. diameter | Ø min min. diameter | Bocche tipo Ports type |
| APERTA | 1 Elica | 33 mm | 156 mm | --- mm | DIN 11851 |
| | | | | | Bocca aspir. Suction port |
| | | | | | DN 65 |
| | | | | | Bocca mand. Discharge port |
| | | | | | DN 65 |
| CARATTERISTICHE DI FUNZIONAMENTO CON ACQUA PULITA A 20°C - PESO SPECIFICO 1 (kg/dm³) Curves show performance with clear water at 70°F - Specific gravity 1 (kg/dm ³) | | | | | |

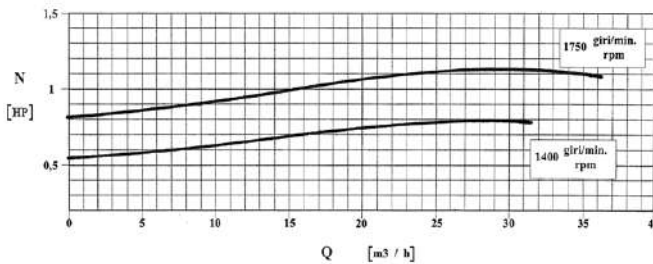
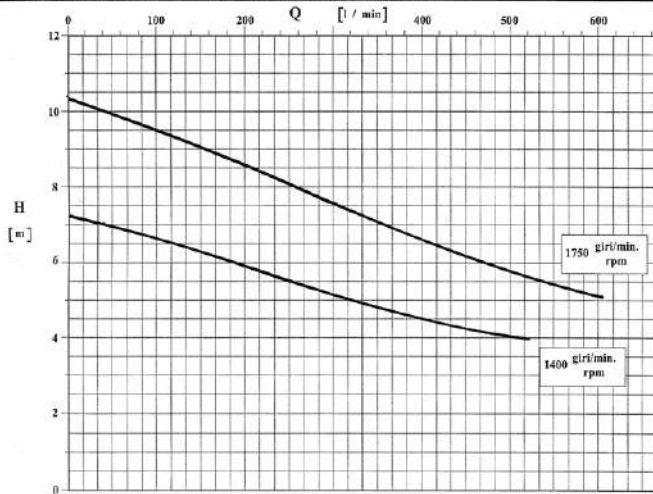

| | | | | | |
|---|----------------------------------|-------------------------------------|-------------------------------|---|--------------------------------------|
| POMPA TIPO Pump type | | CR 80 | | n 1450/1750 giri / min r. p. m. | |
| GIRANTE — Impeller | | | | | |
| TIPO Type | N° di pale n° of vanes | Pass. sferico max. sphere | Ø max max. diameter | Ø min min. diameter | Bocche tipo Ports type |
| APERTA | 1 Elica | 45 mm | 178 mm | --- mm | DIN 11851 |
| | | | | | Bocca aspir. Suction port |
| | | | | | DN 80 |
| | | | | | Bocca mand. Discharge port |
| | | | | | DN 80 |
| CARATTERISTICHE DI FUNZIONAMENTO CON ACQUA PULITA A 20°C - PESO SPECIFICO 1 (kg/dm³) Curves show performance with clear water at 70°F - Specific gravity 1 (kg/dm ³) | | | | | |

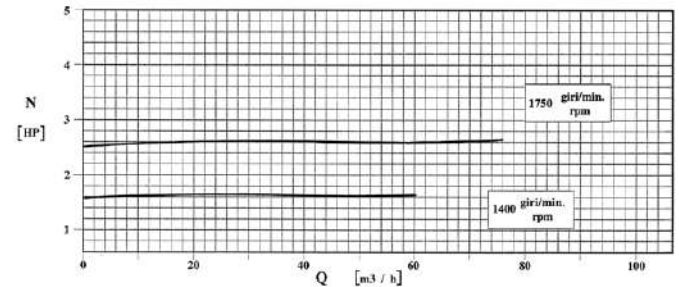
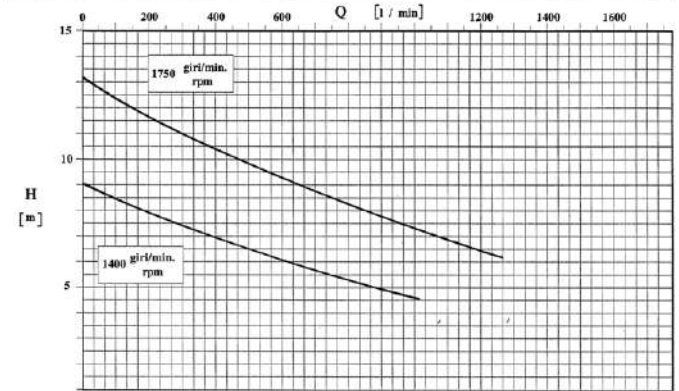

| | | | | | |
|---|----------------------------------|-------------------------------------|-------------------------------|---|--------------------------------------|
| POMPA TIPO Pump type | | CR 100 | | n 1450/1750 giri / min r. p. m. | |
| GIRANTE — Impeller | | | | | |
| TIPO Type | N° di pale n° of vanes | Pass. sferico max. sphere | Ø max max. diameter | Ø min min. diameter | Bocche tipo Ports type |
| APERTA | 1 Elica | 58 mm | 210 mm | --- mm | DIN 11851 |
| | | | | | Bocca aspir. Suction port |
| | | | | | DN 100 |
| | | | | | Bocca mand. Discharge port |
| | | | | | DN 100 |
| CARATTERISTICHE DI FUNZIONAMENTO CON ACQUA PULITA A 20°C - PESO SPECIFICO 1 (kg/dm³) Curves show performance with clear water at 70°F - Specific gravity 1 (kg/dm ³) | | | | | |

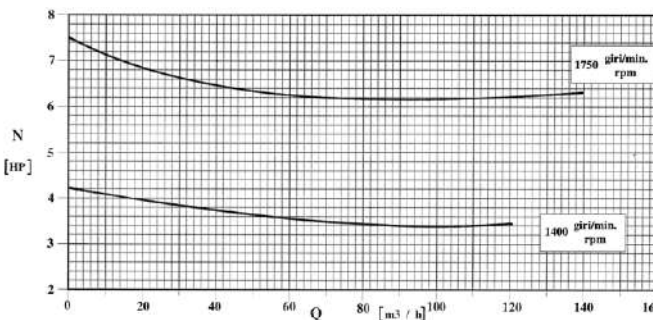
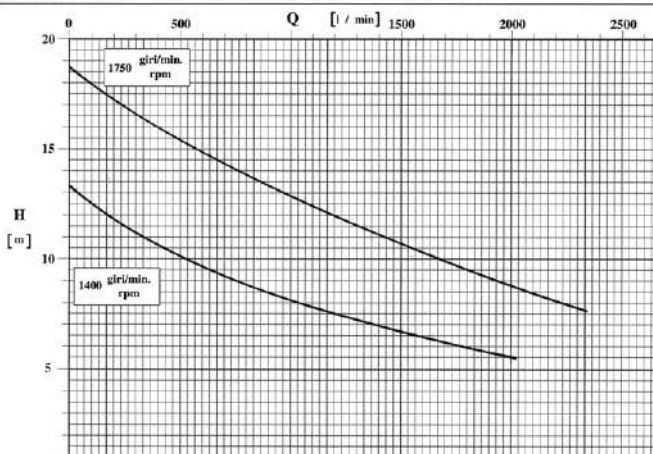

| | | | | | |
|---|----------------------------------|-------------------------------------|-------------------------------|---|--------------------------------------|
| POMPA TIPO Pump type | | CR 125 | | n 1450/1750 giri / min r. p. m. | |
| GIRANTE — Impeller | | | | | |
| TIPO Type | N° di pale n° of vanes | Pass. sferico max. sphere | Ø max max. diameter | Ø min min. diameter | Bocche tipo Ports type |
| APERTA | 1 Elica | 63 mm | 260 mm | --- mm | DIN 11851 |
| | | | | | Bocca aspir. Suction port |
| | | | | | DN 125 |
| | | | | | Bocca mand. Discharge port |
| | | | | | DN 125 |
| CARATTERISTICHE DI FUNZIONAMENTO CON ACQUA PULITA A 20°C - PESO SPECIFICO 1 (kg/dm³) Curves show performance with clear water at 70°F - Specific gravity 1 (kg/dm ³) | | | | | |

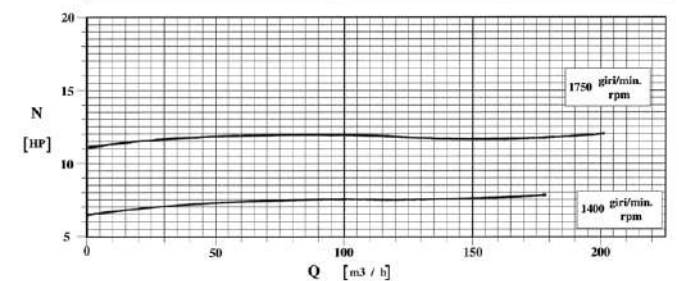
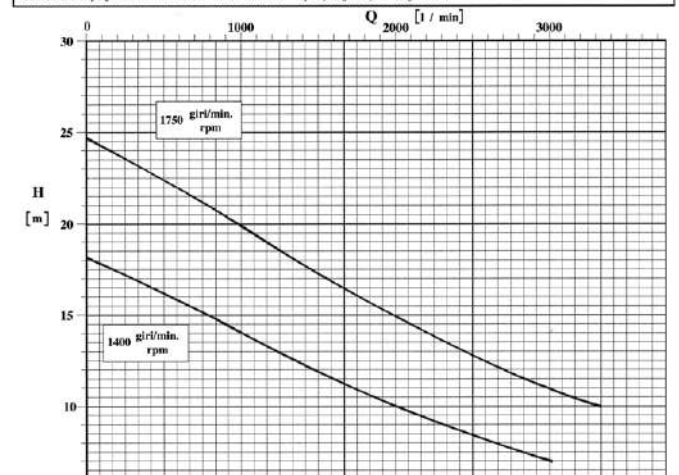

ÄUßERE ABMESSUNGEN

Unverbindliche Werte - DN = Gewindestutzen DIN 11851 - Ausf. mit Standard-Motoren IEC - EN

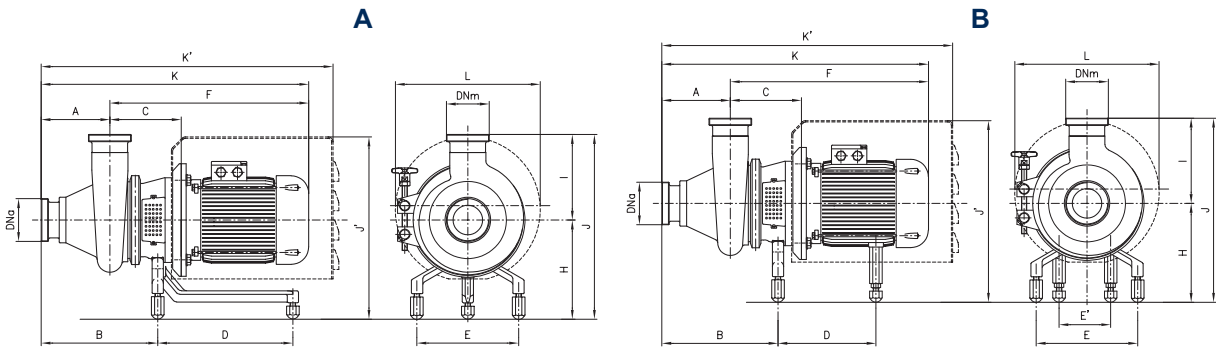

A = Motoren 0,55 kW bis 4 kW

| Pumpentyp | kW | DNa | DNm | A | B | C | D | E | E' | F | H | K | K' | I | J | J' | L |
|------------|------|-----|-----|-----|-----|-----|-----|-----|----|-----|-----|-----|-----|-----|-----|-----|-----|
| 1450 U/min | | | | | | | | | | | | | | | | | |
| CR 65 | 0,55 | 65 | 65 | 151 | 257 | 158 | 230 | 225 | - | 392 | 208 | 543 | 657 | 190 | 398 | 374 | 302 |
| | 0,75 | | | | | | | | | | | 588 | | | | | |
| | 1,1 | | | | | | | | | | | 437 | | | | | |
| | 1,5 | | | | | | | | | | | 452 | | | | | |
| CR 80 | 1,1 | 80 | 80 | 181 | 297 | 168 | 300 | 225 | - | 452 | 213 | 632 | 699 | 245 | 458 | 379 | 302 |
| | 1,5 | | | | | | | | | | | 699 | | | | | |
| | 2,2 | | | | | | | | | | | 508 | | | | | |
| | 3 | | | | | | | | | | | 508 | | | | | |
| CR 100 | 2,2 | 100 | 100 | 205 | 337 | 202 | 300 | 225 | - | 536 | 238 | 741 | 824 | 296 | 534 | 443 | 330 |
| | 3 | | | | | | | | | | | 741 | | | | | |
| | 4 | | | | | | | | | | | 536 | | | | | |
| | 4 | | | | | | | | | | | 536 | | | | | |

B = Motoren 5,5 kW bis 15 kW

| Pumpentyp | kW | DNa | DNm | A | B | C | D | E | E' | F | H | K | K' | I | J | J' | L |
|------------|-----|-----|-----|-----|-----|-----|-------|-----|-----|-----|-----|-----|-----|-----|-----|-----|-----|
| 1450 U/min | | | | | | | | | | | | | | | | | |
| CR 100 | 5,5 | 100 | 100 | 205 | 325 | 204 | 281,7 | 225 | 180 | 576 | 238 | 784 | 848 | 294 | 526 | 460 | 370 |
| | 7,5 | | | | | | 319,7 | | | | | | | | | | |
| | 11 | | | | | | 408 | | | | | | | | | | |
| | 15 | | | | | | 408 | | | | | | | | | | |
| CR 125 | 5,5 | 125 | 125 | 232 | 370 | 230 | 281,7 | 225 | 180 | 604 | 238 | 836 | 900 | 346 | 584 | 501 | 430 |
| | 7,5 | | | | | | 319,7 | | | | | | | | | | |
| | 11 | | | | | | 412 | | | | | | | | | | |
| | 15 | | | | | | 412 | | | | | | | | | | |

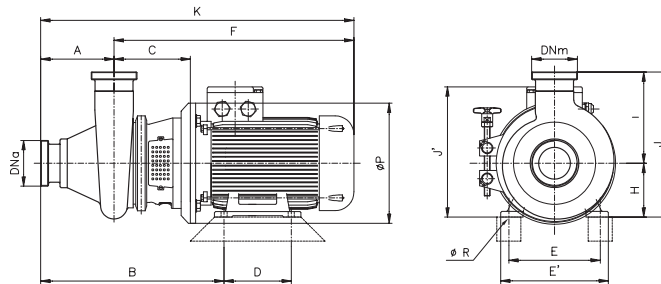

| Pumpentyp | kW | DNa | DNm | A | B | C | D | E | E' | F | H | K | I | J | J' | ØP | ØR |
|------------|------|-----|-----|-----|-----|-----|-----|-----|-----|-----|-----|-----|-----|-----|-----|-----|----|
| 1450 U/min | | | | | | | | | | | | | | | | | |
| CR 65 | 0,55 | 65 | 65 | 151 | 360 | 158 | 100 | 125 | 150 | 392 | 80 | 543 | 190 | 270 | 200 | 200 | 10 |
| | 0,75 | | | | 362 | | | 140 | 165 | 437 | 90 | 588 | | 280 | 218 | | |
| | 1,1 | | | | 406 | | | 160 | 196 | 481 | 100 | 663 | | 335 | 218 | | |
| | 1,5 | | | | 413 | | | 190 | 226 | 502 | 112 | 684 | | 345 | 235 | | |
| CR 80 | 1,1 | 80 | 80 | 181 | 406 | 168 | 125 | 140 | 165 | 452 | 90 | 632 | 245 | 335 | 218 | 200 | 10 |
| | 1,5 | | | | | | 140 | 196 | 481 | 100 | 663 | 345 | | 235 | | | |
| | 2,2 | | | | | | 160 | 196 | 481 | 100 | 663 | 345 | | 235 | | | |
| | 3 | | | | | | 190 | 226 | 502 | 112 | 684 | 357 | | 260 | | | |
| CR 100 | 2,2 | 100 | 100 | 205 | 477 | 202 | 140 | 190 | 240 | 515 | 112 | 720 | 294 | 406 | 331 | 250 | 12 |
| | 3 | | | | | | 190 | 240 | 542 | 112 | 747 | 406 | | 367 | | | |
| | 4 | | | | | | 216 | 256 | 576 | 132 | 781 | 426 | | 299 | | | |
| | 5,5 | | | | | | 216 | 256 | 576 | 132 | 781 | 426 | | 299 | | | |
| CR 125 | 5,5 | 125 | 125 | 232 | 550 | 230 | 140 | 216 | 256 | 604 | 132 | 836 | 346 | 478 | 404 | 300 | 12 |
| | 7,5 | | | | | | 178 | 256 | 604 | 132 | 836 | 506 | | 432 | | | |
| | 11 | | | | | | 216 | 256 | 604 | 132 | 836 | 506 | | 432 | | | |
| | 15 | | | | | | 254 | 300 | 748 | 160 | 980 | 506 | | 432 | | | |



C.S.F. Inox S.p.A. Strada per Bibbiano, 7 - 42027 Montecchio E. (RE) - ITALY EU

Ph +39.0522.869911 r.a. - Fx +39.0522.865454 - italia@csf.it - www.csf.it

Export Department • Commercial Étranger • Comercial Extranjero

Ph +39.0522.869922 - Fx +39.0522.869841 - export@csf.it - www.csf.it



Alle Angaben, Daten und Darstellungen (in welcher Form auch immer), die in diesem Dokument aufgeführt sind, sind indikativ und nicht bindend. C.S.F. bürgt nicht und geht keine Verpflichtung ein für die Nutzung dieses Dokuments und die darin enthaltenen Informationen. Insbesondere garantiert C.S.F. nicht gegen Auslassungen oder Fehler der hier angegebenen Daten und Zeichnungen. Beachten Sie, dass die technischen Spezifikationen, Informationen und Darstellungen in diesem Dokument lediglich indikativ und annähernd und daher nicht zwingend exakt sind. Die C.S.F. INOX behält sich das Recht vor, jederzeit und ohne Vorankündigung die in diesem Dokument angegebenen Daten, Zeichnungen und Informationen zu ändern.