



BOMBAS CENTRÍFUGAS SANITARIAS Serie CR



HYGIENE BIOTECHNOLOGY INDUSTRIAL

Bombas centrífugas de turbina helicoidal.

Partes en contacto con el fluido realizadas en acero inoxidable tipo CF-3M 1.4404/AISI 316L.

Fundiciones a la cera perdida y tratamiento de pulido electroquímico, garantizan un nivel óptimo de acabado superficial.

Motores independientes tipo IEC.

Gracias al sistema de cierre del cuerpo mediante una abrazadera, son fácilmente desmontables para inspección, limpieza y mantenimiento; además la boca de impulsión puede girarse en cualquier dirección.

Movimiento delicado sin interrupciones.

Las características de proyecto de las bombas de la serie CR permiten una velocidad de flujo del producto extremadamente baja que unida a la configuración particular de la turbina helicoidal determina una transporte delicado.



Bomba CR carenada

Unen las propiedades de las bombas centrífugas a la delicadeza de una bomba volumétrica de rotor helicoidal. Esto permite su uso con productos de una consistencia alta y con presencia de partes sólidas. Las bombas de la serie CR son la elección ideal en los sectores de transformación de los productos alimentarios:

Transporte de verdura y fruta, cereales, transporte de pescado, pastas alimentarias, aceite, remontado de vinos.

DATOS TÉCNICOS

Caudales hasta 150 m³/h

Presiones hasta 20 m

Presión máxima de funcionamiento 10 bar hasta 100°C

Rango de temperatura -10° ÷ + 100°

Ejecución cierre mecánico:

Cierre mecánico interno unificado según EN 12756, ISO 3069.

Cierre mecánico interno simple

Cierre mecánico externo simple

Cierre mecánico doble refrigerado

Materiales de las juntas (FDA y reg. europeo 1935/2004):

Nitrilo (NBR)

Etileno-Propileno (EPDM)

Fluorado (FPM - FKM)

FEP

FFPM - FFKM

Silicona

Conexiones para las bocas de unión:

DIN - SMS - IDF - BS/RJT - DS CLAM y bridas EN1092-1 PN16 las adaptan a todas las normativas internacionales.

DIAGRAMAS GENERALES

(Prestaciones referidas a 20 °C - 1013 mBar, Datos no vinculantes)

POMPA TIPO <i>Pump type</i>		CR 65			n 920/1110	giri / min <i>r. p. m.</i>
GIRANTE — Impeller						
TIPO <i>Type</i>	N° di pale <i>n° of vanes</i>	Pass. sferico <i>max. sphere</i>	Ø max <i>max. diameter</i>	Ø min <i>min. diameter</i>	Bocche tipo <i>Ports type</i>	Bocca aspir. <i>Suction port</i>
APERTA	1 Elica	33 mm	156 mm	— mm	DIN 11851	DN 65
						Bocca mand. <i>Discharge port</i>
						DN 65
CARATTERISTICHE DI FUNZIONAMENTO CON ACQUA PULITA A 20°C - PESO SPECIFICO 1 (kg/dm ³)						
<i>Curves show performance with clear water at 70°F - Specific gravity 1 (kg/dm³)</i>						

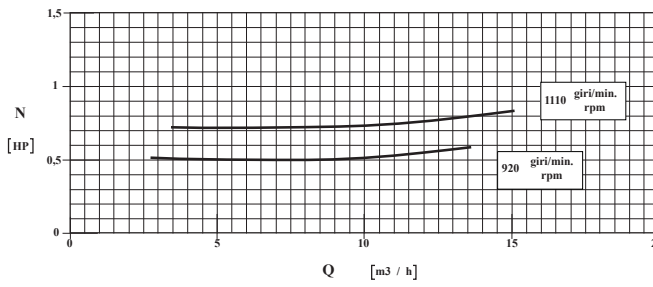
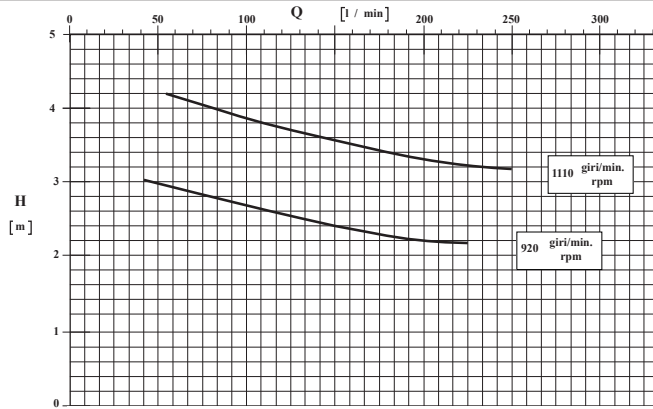

POMPA TIPO <i>Pump type</i>		CR 80			n 960/1150	giri / min <i>r. p. m.</i>
GIRANTE — Impeller						
TIPO <i>Type</i>	N° di pale <i>n° of vanes</i>	Pass. sferico <i>max. sphere</i>	Ø max <i>max. diameter</i>	Ø min <i>min. diameter</i>	Bocche tipo <i>Ports type</i>	Bocca aspir. <i>Suction port</i>
APERTA	1 Elica	45 mm	178 mm	— mm	DIN 11851	DN 80
						Bocca mand. <i>Discharge port</i>
						DN 80
CARATTERISTICHE DI FUNZIONAMENTO CON ACQUA PULITA A 20°C - PESO SPECIFICO 1 (kg/dm ³)						
<i>Curves show performance with clear water at 70°F - Specific gravity 1 (kg/dm³)</i>						

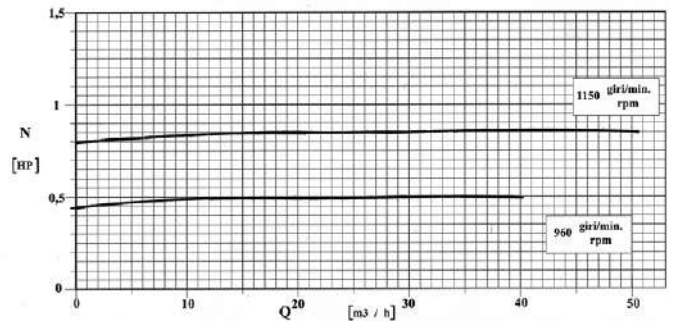
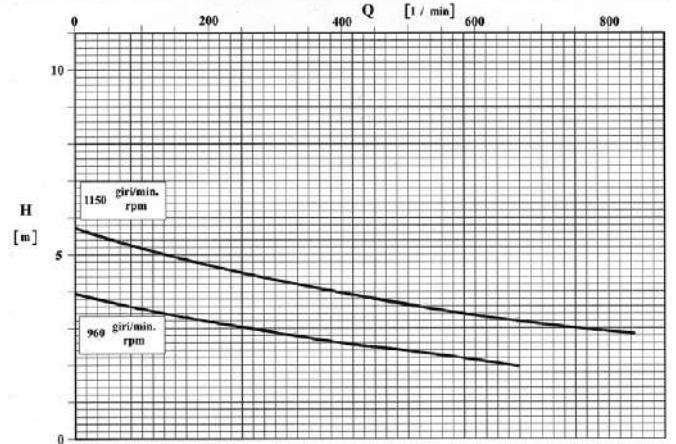

POMPA TIPO <i>Pump type</i>		CR 100			n 960/1150	giri / min <i>r. p. m.</i>
GIRANTE — Impeller						
TIPO <i>Type</i>	N° di pale <i>n° of vanes</i>	Pass. sferico <i>max. sphere</i>	Ø max <i>max. diameter</i>	Ø min <i>min. diameter</i>	Bocche tipo <i>Ports type</i>	Bocca aspir. <i>Suction port</i>
APERTA	1 Elica	58 mm	210 mm	— mm	DIN 11851	DN 100
						Bocca mand. <i>Discharge port</i>
						DN 100
CARATTERISTICHE DI FUNZIONAMENTO CON ACQUA PULITA A 20°C - PESO SPECIFICO 1 (kg/dm ³)						
<i>Curves show performance with clear water at 70°F - Specific gravity 1 (kg/dm³)</i>						

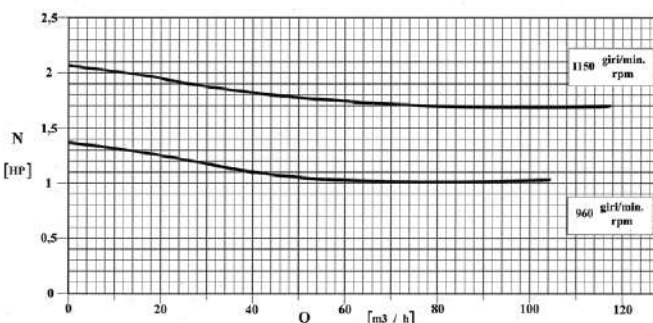
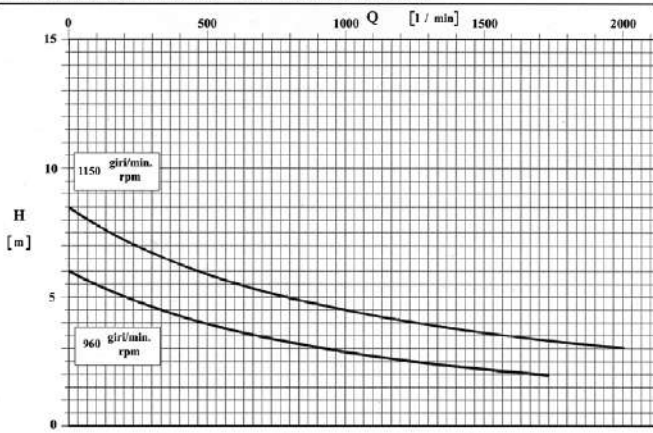

POMPA TIPO <i>Pump type</i>		CR 125			n 960/1150	giri / min <i>r. p. m.</i>
GIRANTE — Impeller						
TIPO <i>Type</i>	N° di pale <i>n° of vanes</i>	Pass. sferico <i>max. sphere</i>	Ø max <i>max. diameter</i>	Ø min <i>min. diameter</i>	Bocche tipo <i>Ports type</i>	Bocca aspir. <i>Suction port</i>
APERTA	1 Elica	63 mm	260 mm	— mm	DIN 11851	DN 125
						Bocca mand. <i>Discharge port</i>
						DN 125
CARATTERISTICHE DI FUNZIONAMENTO CON ACQUA PULITA A 20°C - PESO SPECIFICO 1 (kg/dm ³)						
<i>Curves show performance with clear water at 70°F - Specific gravity 1 (kg/dm³)</i>						

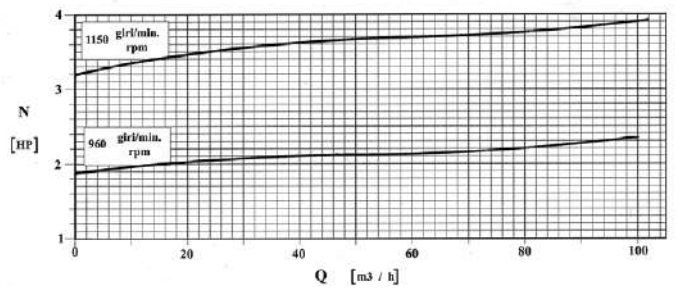
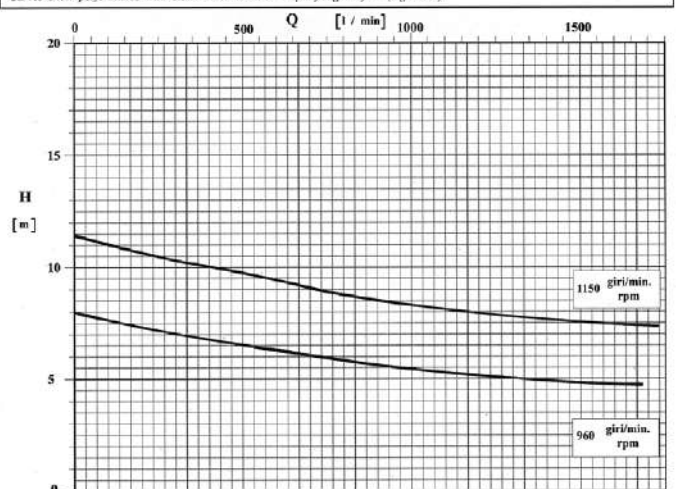

POMPA TIPO Pump type		CR 65		n 1400/1750 giri / min r. p. m.	
GIRANTE — Impeller					
TIPO Type	N° di pale n° of vanes	Pass. sferico max. sphere	Ø max max. diameter	Ø min min. diameter	Bocche tipo Ports type
APERTA	1 Elica	33 mm	156 mm	--- mm	DIN 11851
					Bocca aspir. Suction port
					DN 65
					Bocca mand. Discharge port
					DN 65
CARATTERISTICHE DI FUNZIONAMENTO CON ACQUA PULITA A 20°C - PESO SPECIFICO 1 (kg/dm³) Curves show performance with clear water at 70°F - Specific gravity 1 (kg/dm ³)					

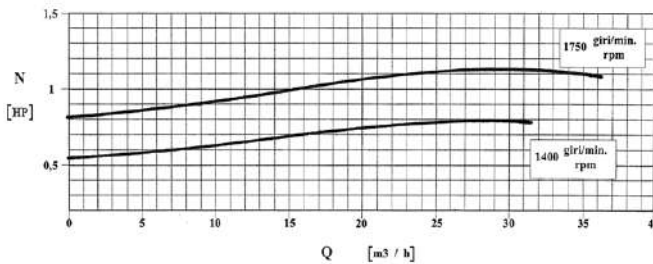
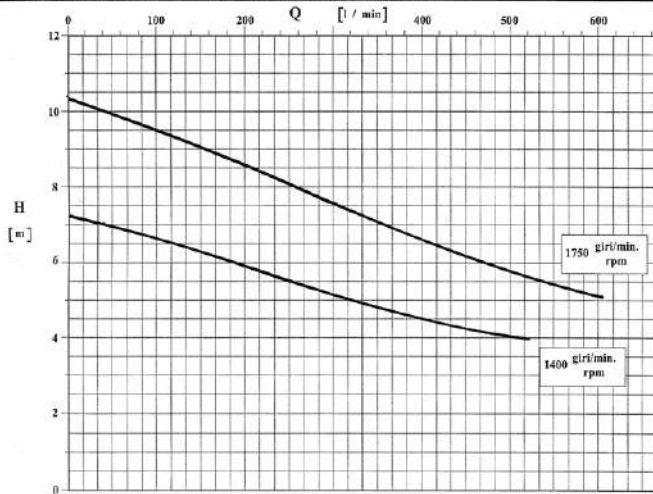

POMPA TIPO Pump type		CR 80		n 1450/1750 giri / min r. p. m.	
GIRANTE — Impeller					
TIPO Type	N° di pale n° of vanes	Pass. sferico max. sphere	Ø max max. diameter	Ø min min. diameter	Bocche tipo Ports type
APERTA	1 Elica	45 mm	178 mm	--- mm	DIN 11851
					Bocca aspir. Suction port
					DN 80
					Bocca mand. Discharge port
					DN 80
CARATTERISTICHE DI FUNZIONAMENTO CON ACQUA PULITA A 20°C - PESO SPECIFICO 1 (kg/dm³) Curves show performance with clear water at 70°F - Specific gravity 1 (kg/dm ³)					

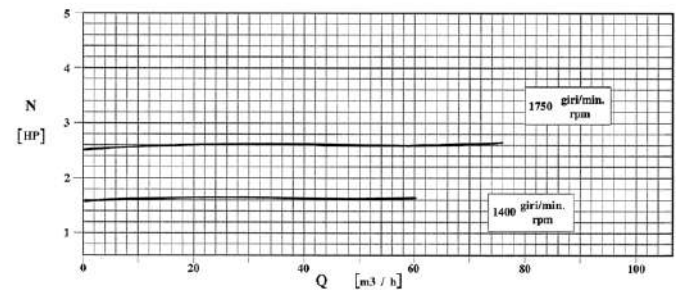
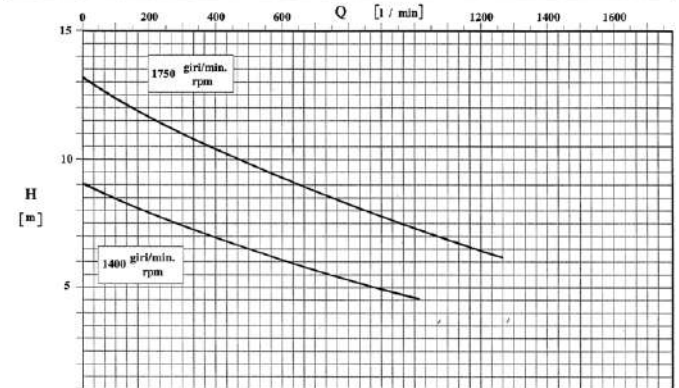

POMPA TIPO Pump type		CR 100		n 1450/1750 giri / min r. p. m.	
GIRANTE — Impeller					
TIPO Type	N° di pale n° of vanes	Pass. sferico max. sphere	Ø max max. diameter	Ø min min. diameter	Bocche tipo Ports type
APERTA	1 Elica	58 mm	210 mm	--- mm	DIN 11851
					Bocca aspir. Suction port
					DN 100
					Bocca mand. Discharge port
					DN 100
CARATTERISTICHE DI FUNZIONAMENTO CON ACQUA PULITA A 20°C - PESO SPECIFICO 1 (kg/dm³) Curves show performance with clear water at 70°F - Specific gravity 1 (kg/dm ³)					

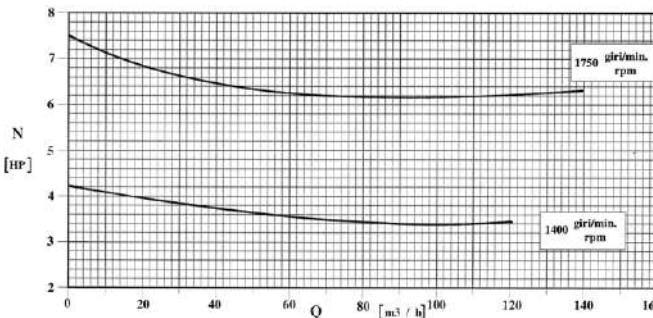
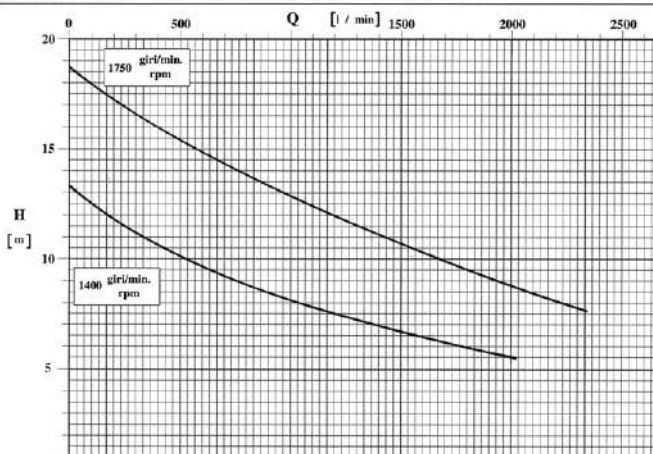

POMPA TIPO Pump type		CR 125		n 1450/1750 giri / min r. p. m.	
GIRANTE — Impeller					
TIPO Type	N° di pale n° of vanes	Pass. sferico max. sphere	Ø max max. diameter	Ø min min. diameter	Bocche tipo Ports type
APERTA	1 Elica	63 mm	260 mm	--- mm	DIN 11851
					Bocca aspir. Suction port
					DN 125
					Bocca mand. Discharge port
					DN 125
CARATTERISTICHE DI FUNZIONAMENTO CON ACQUA PULITA A 20°C - PESO SPECIFICO 1 (kg/dm³) Curves show performance with clear water at 70°F - Specific gravity 1 (kg/dm ³)					

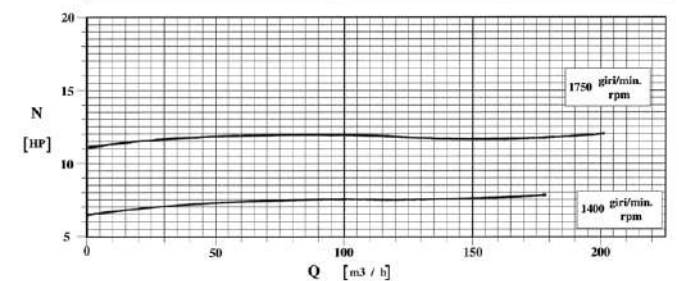
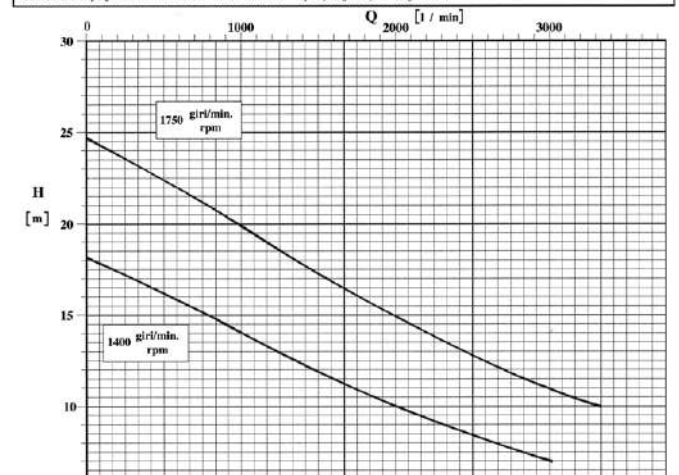

DIMENSIONES

Cotas aproximadas – DN = Rosca macho DIN - 11851 – Ejec. con motores estándar IEC-EN

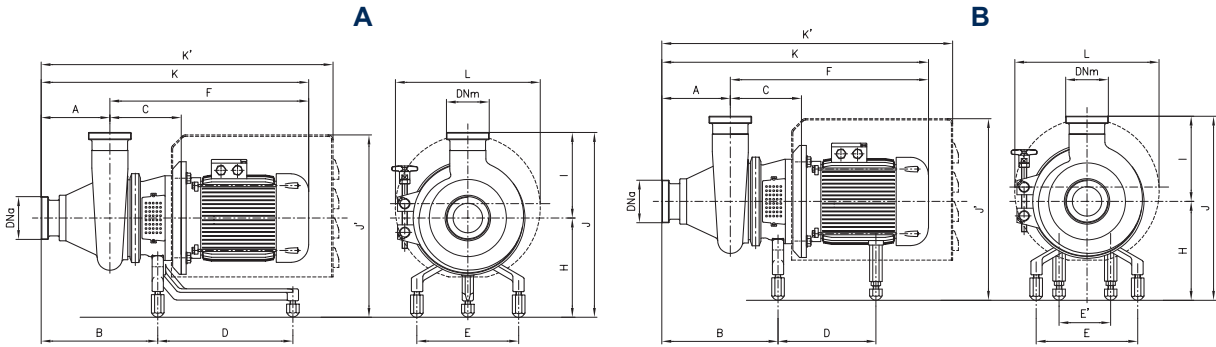

A = Motores desde 0,55 kW a 4 kW

Bomba tipo	kW	DNa	DNm	A	B	C	D	E	E'	F	H	K	K'	I	J	J'	L				
1450 rpm																					
CR 65	0,55	65	65	151	257	158	230	225	-	392	208	543	657	190	398	374	302				
	0,75									437		588									
	1,1									452		632						699			
CR 80	1,1	80	80	181	297	168	300	225	-	508	230	690	767	245	458	379	302				
	1,5									508		690			767	475	435	330			
	2,2									508		690			767	475	435	330			
CR 100	2,2	100	100	205	337	202	300	225	-	536	238	741	824	296	534	443	330				
	3									536		741						824	534	443	330
	4									536		741						824	534	443	330

B = Motores desde 5,5 kW a 15 kW

Bomba tipo	kW	DNa	DNm	A	B	C	D	E	E'	F	H	K	K'	I	J	J'	L
1450 rpm																	
CR 100	5,5	100	100	205	325	204	281,7	225	180	576	238	784	848	294	526	460	370
	7,5						319,7										
	11						408										
	15						408										
CR 125	5,5	125	125	232	370	230	281,7	225	180	604	238	836	900	346	584	501	430
	7,5						319,7										
	11						412										
	15						412										

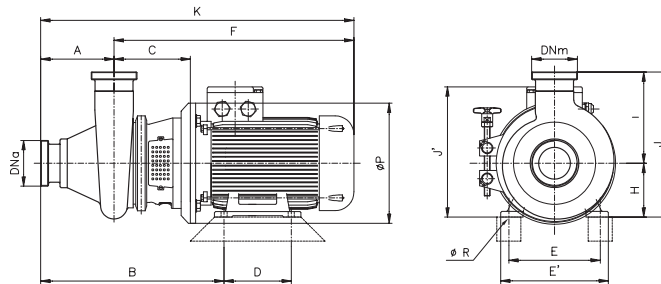

Bomba tipo	kW	DNa	DNm	A	B	C	D	E	E'	F	H	K	I	J	J'	ØP	ØR	
1450 rpm																		
CR 65	0,55	65	65	151	360	158	100	125	150	392	80	543	190	270	200	200	10	
	0,75				362			140	165	437	90	588		280	218			
	1,1				362			140	165	437	90	588		280	218			
CR 80	1,1	80	80	181	406	168	125	140	165	452	90	632	245	335	218	200	10	
	1,5				413		160	196	481	100	663	345		235				
	2,2				413		160	196	481	100	663	345		235				
CR 100	2,2	100	100	205	477	202	140	190	240	515	112	720	294	406	331	250	12	
	3				497		178	216	256	576	132	781		426	299	300	12	
	4				497		178	216	256	576	132	781		426	299	300	12	
	5,5				570		257	210	190	240	734	160		937	454	357	350	15
CR 125	5,5	125	125	232	550	230	140	216	256	604	132	836	346	478	404	300	12	
	7,5				610		270	210	254	300	748	160		980	506	432	350	15
	11				610		270	210	254	300	748	160		980	506	432	350	15



C.S.F. Inox S.p.A. Strada per Bibbiano, 7 - 42027 Montecchio E. (RE) - ITALY EU

Ph +39.0522.869911 r.a. - Fx +39.0522.865454 - italia@csf.it - www.csf.it

Export Department • Commercial Étranger • Comercial Extranjero

Ph +39.0522.869922 - Fx +39.0522.869841 - export@csf.it - www.csf.it



Todas las otras indicaciones, datos y representaciones realizadas que incluye la presente publicación son indicativos y no constituyen ningún vínculo. C.S.F. INOX no acepta ninguna garantía ni obligación por la utilización del presente documento, por lo que se refiere a la información aquí incluida. Pero sobretodo declina cualquier tipo de responsabilidad por omisiones y/o errores en los datos y dibujos del documento. Se precisa que los datos técnicos, la información y las representaciones incluidas en el presente documento son de un valor puramente indicativo y aproximado. C.S.F. INOX se reserva el derecho de poder modificar los datos, los dibujos y la información del presente documento en cualquier momento y sin necesidad de aviso previo.